

COMMENTS FROM THE MAYOR
By Charles Jessup



New City Secretary

Courtney Rutherford is our new City Secretary and it looks like we got a good one. She was selected and recommended to Council –who by law has to approve the hiring – by a question and interview panel made up of Carrie Gregg; Alderman John Isbell; Stacie Kopczynski; Alderman Steven H. Bezner and myself. We received

numerous resumes from around the country with the ones likely to be interviewed being submitted to rigorous background checks. Some didn't make it. Courtney's background checks not only proved flawless, the support from those who worked with her were very favorable.

Her background includes being the Administrative Assistant / Assistant City Secretary for the city of Jersey Village. There she worked her way up through the various departments working as the city Accounting Clerk and processing utility bills and warrants for court, working with municipal court dockets, processing property taxes, records management and budgets. All of which are critical and very specific in a municipal setting. Her experience will add depth to our administration. Courtney is a very friendly person, so next time you are at City Hall, stop off and say hello.

Aldi One Step Closer to putting store in Meadows Place

At the January City Council Meeting, your City Council passed Ordinance 2016-06 which contained the provisions needed to accommodate the construction of an Aldi grocery store right here in Meadows Place. Bob Graf, of our EDC, and I confirmed the approval of the Meadows Place site with Mike Lucido, the Director of Real Estate for Aldi. For those unfamiliar with Aldi, it was recognized as the nation's low-price grocery leader for the fourth year in a row and consumers ranked ALDI ahead of competitors such as Costco and Trader Joe's and Consumers also named ALDI one of the top three favorite grocery store chains in America.

(Continued on page 3)

GAMPOUT IN THE PARK



MARCH 12

**Come and experience the
great outdoors first hand.**

REGISTRATION REQUIRED

For more information, see page 10.

CITY CALENDAR

Meetings

- Feb. 14** Happy Valentine's Day
- Feb. 26** City Council Workshop Meeting
6:00 p.m.
- Feb. 26** City Council Regular Meeting
7:30 p.m.

Fort Bend ISD

- Feb. 12** Early Student Release – All Levels
- Feb. 15** President's Day – Student Holiday

Did You Know?...

Did You Know... City Council renewed or appointed new members to Meadows Place Planning & Zoning (P&Z); Board of Adjustments and the Economic Development Corporation (EDC)? These organizations play a very important role in our city and we are blessed to have such wise and willing people working for our city. A big Thank You to: P&Z members Heidi Case, Bob McDonald, Ever Ramirez, Brian Swinney and Sean M. Ulrey. Those serving on our Board of Adjustment are: Nelson Goolsby; Benet Gaitos, Doug Schroeder; David Piwonka and Clyde Little. Our Economic Development Directors are: Margaret Sandlin; Harry Hamilton, Clyde Little, Matthew Walker, Kurt Kopczyński and Bob Graf. Thank You all for helping Meadows Place to be... *Your Place for Life.*

Did You Know... we had a great response to our Christmas Tree recycling program? These trees will be used for mulch in various parts of the city. Thanks to all who participated.

Did You Know... there are several ways to Contact Meadows Place? The back of newsletter gives you info, including Council contact information. Our website has contact info and very helpful links to other sites and don't forget our Meadows Place Facebook Page. Bottom line is, if you have a question or a concern, touch base with us. We love to hear of ways we may be able to better serve you.

Speaking of better **Did You Know...** we are always trying to find little things that will make a big difference – like the bridge railing on Montecito, or trimming the trees in the park, or (soon) the new flower beds at the city's entryway signs? And how about that new Hike & Bike Trail! EDC helped us out on that one. The point is, we are always working to maintain and upgrade Meadows Place. Thanks to our Parks and Public Works departments who carry most of that load. If you have an (inexpensive) idea, let us know!

Did You Know... Alderman Rick Staigle has been invited to speak to the Texas District Institute of Transportation Engineers meeting this year? This is a big deal and quite an honor for Alderman Staigle. I am sure Meadows Place will sneak into his presentation...he is good that way. Congratulations Rick.

Did You Know... Meadows Place has standard paint colors already picked out so you don't have to jump through any hoops to see if the color of paint you pick is approved? Mimi Boos has BEHR paint books and any of the many color combinations in there are pre-approved. Just drop by and look at one or take it with you to the paint store.

Did You Know... March Is Mailbox Month? You get \$10.00 off your utility bill if you paint, straighten up or replace your mailbox. Just take a Before and After photo, submit it to City Hall and bingo, ten dollars off.

Did You Know... Meadows Place has more internal work going on than it has since we were built out? Though some may find it aggravating, I find it very exciting that many of the Meadows Place gas distribution and feed lines are being replaced and upgraded – at no expense to the city! I met with CenterPoint Gas to go over this project and am thankful they included Meadows Place. They should be done in another couple of months. We are also having electrical loops upgraded and have sections of water lines being replaced. Please be patient. It will be worth the mess in our yards when it is done. Thank You.

Did You Know... Bob Graf and his wife were spotted in Atlanta cheering on the Cougars and Chuck McClerkin is regularly on TV with his Fear the Beard support of the Rockets? Fun stuff.

If you have a fun event or someone did something special, drop us a note or email: mayor@cityofmeadowsplace.org. Thank You Meadows Place... *Your Place for Life!*

Did You Know... It's official, Meadows Place now has an active YAC organization? YAC - Youth Action Council — met Mayor and Council last month as they begin to gear up to make a real difference in our city. 16 of their 22 members were able to attend: Savannah Cabezas – Chair; Phi Nguyen – Vice Chair; Jessica Robinson – Secretary; Maricar Gomez – Historian; Natalie Shreve - Membership; Caitlyn Ray; May Nguyen; Kathleen Espino; Allie Cabezas; Skyler Cabezas; Jasmine Matamoras; Alexis Moody; Joseph Gonzales; Isela Hernandez; Di Torreros; and Quin Torreros Carter. I am totally confident that YAC will have fun, make a positive impact, and ensure Meadows Place will continue to be - *Your Place for Life!*

(Comments From The Mayor continued from page 1)

Besides being efficient and environmentally sensitive, Aldi has removed certified synthetic colors, partially hydrogenated oils, and added MSG from all of its private-label products, and is expanding its SimplyNature line, which is free of more than 125 artificial ingredients, and its gluten-free liveGfree brand. Besides being free of artificial growth hormones, Alidi's milk prices will benefit both the young family with children and senior citizens on a budget. This small forward thinking store should be a perfect a perfect fit for our small forward thinking city. If all goes well, we should see construction start this summer.

We will keep you informed on the progress. The arrival of Aldi will be one more step in keeping Meadows Place, **Your Place for Life.**

Sex Offender Restriction Lawsuit

I would like to thank everyone who attended the Special Meeting on January 20th. We had a full house, and for that I am thankful as well. For those not at the meeting, Meadows Place is one of several General Law cities in Texas being sued because we have an ordinance establishing Safe Zones and restricting sex offenders from living 2,000 feet from schools, playgrounds, pools, parks, etc. Your Council and your Police Chief were ready to stand and fight for our right to protect ourselves via ordinance, but I felt I had to let you know there is a cost associated with it, and no guarantees. The public was allowed to speak, ask questions and give input. Through that questioning, we found the Chief had effectively used our ordinance to keep Sex Offenders out of the city on more than one occasion. Then, before Council retreated into Executive Session to deliberate our legal positions and discuss strategy, your Mayor and Council received 100% Unanimous Support to let our legal counsel pick up the gauntlet and fight. That is where we stand at this time. It is very intense but rest assured, we clearly heard our marching orders and will be doing everything we can to protect our city, especially our children, and fight for the right of Meadows Place to protect itself from sexual predators just like the larger cities can. Please feel free to contact the Mayor's office if you have any questions – and thanks again to all who turned out to help us regarding this very important matter.

COP TALK

By Chief Gary Stewart



IRS Scams

The Meadows Place Police Department would like to remind everyone it is Tax Season again and the Scammers are out there. Here are some tips from the IRS. If you suspect you may have been a victim, please contact the Meadows Place Police Department or IRS (800-366-4484) to report suspicious activity.

The IRS continues to warn consumers to guard against scam phone calls from thieves intent on stealing their money or their identity. Criminals pose as the IRS to trick victims out of their money or personal information. Here are several tips to help you avoid being a victim of these scams:

- **Scammers make unsolicited calls.** Thieves call taxpayers claiming to be IRS officials. They demand that the victim pay a bogus tax bill. They con the victim into sending cash, usually through a prepaid debit card or wire transfer. They may also leave "urgent" callback requests through phone "robo-calls," or via phishing email.
- **Callers try to scare their victims.** Many phone scams use threats to intimidate and bully a victim into paying. They may even threaten to arrest, deport or revoke the license of their victim if they do not get the money.
- **Scams use caller ID spoofing.** Scammers often alter caller ID to make it look like the IRS or another agency is calling. The callers use IRS titles and fake badge numbers to appear legitimate. They may use the victim's name, address and other personal information to make the call sound official.
- **Cons try new tricks all the time.** Some schemes provide an actual IRS address where they tell the victim to mail a receipt for the payment they make. Others use emails that contain a fake IRS document with a phone number or an email address for a reply. These scams often use official IRS letterhead in emails or regular mail that they send to their victims. They try these ploys to make the ruse look official.

The IRS will not:

- Call you to demand immediate payment. The IRS will not call you if you owe taxes without first sending you a bill in the mail.
- Demand that you pay taxes and not allow you to question or appeal the amount you owe.
- Require that you pay your taxes a certain way. For instance, require that you pay with a prepaid debit card.
- Ask for your credit or debit card numbers over the phone.
- Threaten to bring in police or other agencies to arrest you for not paying. ***If you don't owe taxes,*** or have no reason to think that you do: Do not give out any information. Hang up immediately.

The Meadows Place Police Department is available 24 hours a day, seven days a week (281) 983-2900

Household Hazardous Waste



By Danny Segundo

Here are some tips to help you reduce the amount of household hazardous waste (HHW) you generate and properly use, store, and dispose of those products.

First, Be a Good Consumer

Before you buy a product...

- Think about the job at hand.
- Research the type of product(s) you need to effectively perform the job.
- Read product labels carefully.
- Choose the product that is best for the job.
- Consider purchasing environmentally safe products or make your own less toxic alternative product.

Before you use a product...

- Read the label and follow the directions for proper use.
- Follow all safety precautions. (Wear recommended gloves and safety glasses)
- Use the recommended amount - more is not always better!

After you use a product...

- Read the label and follow directions for proper storage.
- Keep lid tightly closed.
- Keep product in original container with readable labels.

If you must dispose of a product...

- Follow the label directions if provided.
- Contact the manufacturer if no directions are provided.
- Take your HHW to a local HHW collection event or facility for proper disposal.

Residents who are interested in more information about HHW disposal locations can visit the Fort Bend County HHW website at <http://co.fort-bend.tx.us/index.aspx?page=358>



Taking Care of Business

Our Business Neighbors are a very important part of the City. This column is dedicated to those businesses.

Want to see a new business or restaurant in Meadows Place? If you do, then contact the Mayor or an EDC director to see if we can help your wish come true.

Help Bring a Business to Meadows Place!



Meadows Place has some really great businesses. Let's all support them. They need, and deserve, our support.



GARAGE SALE

Dates for 2016:

February	12 & 13
May	13 & 14
August	12 & 13
November	11 & 12

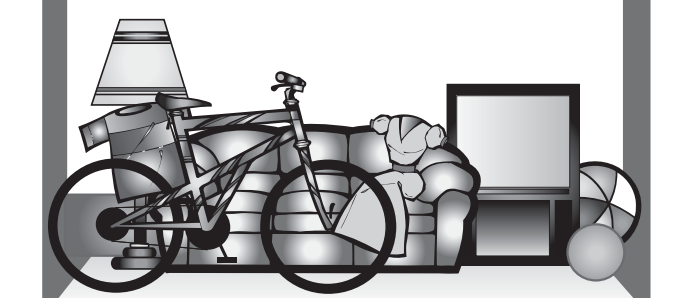



By Jerry Parker

Mailbox Month

March is MAILBOX MONTH here in the City of Meadows Place! This March is the 6th anniversary of this event for our City. Mailbox Month is the time we take a look at the first impression of your home & see what needs to be repaired or replaced, and will result in a **\$10 discount** on your water bill!

Mailboxes are typically constructed to last about 10 years, depending on the materials used, and the USPS states that it is the homeowner's responsibility to maintain and replace worn or damaged mailboxes. If it has been quite a while since you have replaced yours, take an objective look at it.

HOW TO PARTICIPATE: Through the month of March; mail, place in the Utilities Billing Box or e-mail (code-enforcement@cityofmeadowsplace.org) a "before" and "after" photo of your newly rejuvenated or replaced mailbox to City Hall. **Each participating residence will receive a \$10 discount off of their utility bill!**

A quick and easy upgrade is to ensure that your address is prominently displayed!

Some mailboxes only need fresh paint or minor maintenance like rust removal, up-righting the post, etc., while others may need to be replaced altogether. Hardware stores like Lowe's, Home Depot, and Court's Hardware sell reasonably priced replacements, and with a modest amount of effort you will have a fresh new look!

CURBSIDE MAILBOX STANDARDS:

- The bottom of the mailbox should be located between 41 - 45 inches in height from the surface of the curb.
- The name and address on your mailbox should be at least 1 inch letters/numbers.
- The front of your mailbox door should be located 6 - 8 inches from the front face of the curb.

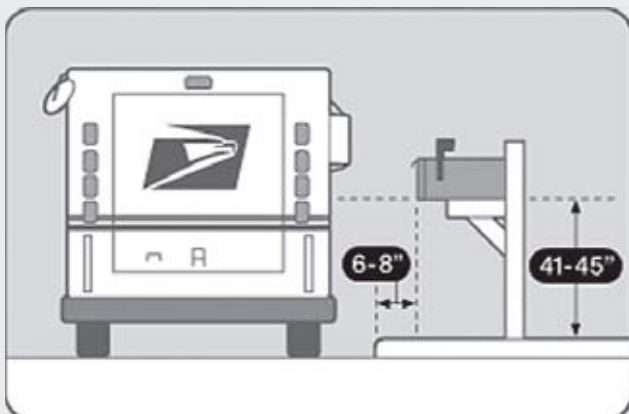

Please contact our local post office if you are considering moving the location of your mailbox.

I would like to thank you in advance, and I am anxious to see just how many of us take advantage and make our beautiful city just a little brighter!

Top Hits from January:

Violation:	Warn/Cit	Comply:
Grass/weeds	1	1
Trees/Shrubs	12	10
Trailer/Car/ Boat	15/2	13
Trash Cans/ Debris	30/8	22
General Nuisance	28	28
Totals	86	79

Please note: If you have a Code Complaint, please go to the City Website, (www.cityofmeadowsplace.org) and fill in the complaint form. 1 violation per complaint please.

Code Enforcement Official • Office: 281-983-2938 •
E-Mail: code-enforcement@cityofmeadowsplace.org



Classified & Advertising

Anyone wishing to place an ad in the newsletter can contact City Hall for information. All ads are due by the second Friday of each month. The appearance of paid advertising is not an endorsement by the City.

• William Sutherland Handyman Repairs. Appliance, Electrical, Plumbing, Clean out sewer line from 2"-8" pipe. Power washing, interior/exterior, Carpentry work, Painting, Concrete, Tiles. Cell 713-384-2817 / 281-568-0308

• Home Daycare enrolling. 22 years experience. References available. Melanie 281-235-2107.

• Registered Home Child Care openings for infants 6 weeks up to 18 months. Good reputation in Meadows Place. Breakfast, lunch provided. Playroom and lots of love. Call Terrie 281-222-3640. Registered for 25 years.

• AFFORDABLE QUALITY ROOFING - Roof leak? Hail damage? Aging roof? We can help. 22 yrs. experience, fully insured, member in good standing of the Houston area Better Business Bureau and an MP resident. We provide excellent workmanship with an excellent warranty, for a free estimate call (713) 484-9398- ROOFING, SIDING, and WINDOWS.

• Baby Bunny Daycare has openings available! 20 + years' experience in my Meadows Place home. Call or email Margaret for more information. New phone number: 832-803-3694 Email: margrussell0317@yahoo.com



Home & Garden Club

By Bob Dybala, Publicity

Belated Happy New Year to all. The Meadows Home and Garden Club is looking forward to a great 2016.

Backing up a little, we need to recognize in the Newsletter the **Christmas Yard of the Month** award winners. It was a close call in most Sections and we congratulate all who helped make Meadows Place "Your Festive Place to Celebrate Christmas." A special mention goes out to the residents of Monticeto Court who made that short street a Christmas wonderland. Award winners by section were:

Section I

Bob and Karen McDonald

Section IVN

The Barry Little Family

Section II

Mr. and Mrs. Jesse Rodriguez

Section IVS

Tuan Doan

Section III

Mr. and Mrs Anthony Kirk

Section V

Rusty and Delores Uhyrek

The Club members and guests enjoyed an informative presentation at our January 12th meeting. Jim Lourim and Elizabeth Sebesta of **The Enchanted Forest** (10611 FM 2759, Richmond, TX 77469) told us how to get our Spring Gardens ready for March planting. Now is the time to get your beds ready. As Jim and Elizabeth stressed: "Better to put a 50 cent plant in a \$2.00 hole than to put a \$2.00 plant in a 50 cent hole." Jim and Elizabeth left us a number of garden care products that were raffled off. Check out the Club's website noted below to get more of the details from their presentation.

The Club is getting ready for its **Spring Home and Garden Tour**, scheduled for Saturday, April 23rd. We already have some homes/gardens committed for the Tour but need a few more. If you have done some remodeling of your home in the past few years and/or have redone your landscaping, consider showing your place off to other Meadows Place residents. Our theme this year is: "Renew and Enjoy Your Home Now!" This reflects a statement made by Ken Pride in a presentation to the Club in January 2014. He noted that some homeowners fix up their homes for sale but never get to enjoy their improvements. You'll be hearing more about the Tour in the months to come.

The Tour, along with our Fall Craft Show, supports our efforts to provide **college scholarships** to Meadows Place residents. If you are a Meadows Place residents and planning to enter or continue a higher education institution, get an application from our website and submit it. Deadline for applications is April 30th. Contact our Scholarship Committee chairpersons, Lee and Karin Noack, at 281-498-5065, if you have questions or need assistance with the application.

Contact us via e-mail at:

meadowshomegardenclub@gmail.com

Visit our web site today.

Meadowshomegardenclub.com

MANN REAL ESTATE

HANK MANN
Broker/Owner



1939 Cascade Ct.
Sugar Land, TX 77479
cell: 713-582-1654
www.har.com/hankmann
hank.mann@earthlink.net

Parks Make Life Better!



LIFEGUARDS WANTED

The City of Meadows Place is accepting lifeguard applications through February 19 for Summer 2016. Applications can be picked up at City of Meadows Place City Hall. You must be at least 15 yrs old to apply and available for **ALL** training dates.

CPR Training: Friday, March 11

6:00 pm – 9:00 pm @ Community Center

Pool Training: Saturday, March 12 & Sunday, March 13

9:00 am – 5:00 pm @ Community Pool



FISHING FOR TROUT

Meadows Lake has been stocked with 750 Rainbow Trout. We encourage residents to catch and take the trout as they do not live past March in the warm waters of Texas. DO NOT take any fish other than the trout as it is against city ordinance. Anyone aged 17 - 64yr is required by state law to have a fishing license, 16 yr & under are exempt.

LIMIT 5 TROUT PER PERSON PER DAY



KAYAK AT THE LAKE

2/15, 1PM @ the Lake (Safe Boating Card or Essentials of Kayaking Training Pre-Requisite) No Fee

Next Class

3/5, 1pm @ the Lake. **Must pre register** -\$15

Meadows Place Parks and Recreation has many ways for you to get out, get active, and get involved.. Stay current with the latest program and event information by checking the City website, Facebook and monthly Newsletter. We are always open to hear your ideas and suggestions, so please call or email your comments to cityofmeadowsplace.org or 281.983.2935.

Register Today

Many of our programs require pre-registration. There are two ways to register. Forms can be found on-line at cityofmeadowsplace.org under the department tab / parks and recreation / programs. Make checks payable to City of Meadows Place then mail to, 1 Troyan Dr. You may also register in person at City Hall, Monday – Friday between 9am – 4pm. If after hours place form & payment in the night drop.

Rentals

If you are looking for a location to host a meeting, celebration or family gathering, the Community Center is a great local option. It can accommodate up to 160 occupants. Tables and chairs are provided with rental. We also offer seasonal rentals of the community pool. Consult the website for more details.

Tennis Court / Pickleball Access

Resident Access Cards are available for purchase at City Hall Monday – Friday 9am-4pm. Cards are \$50 June - December, \$25 after January. Cards are valid through May of each year.





This April the Meadows Place Parks & Recreation Department along with the MPPD will host a Bicycle Rodeo for youth 3yr-up. This program will provide fun obstacle courses, bike and helmet checks and safety guidelines for biking. Bring your bike and helmet to this fun free event.

**4/16 @ Meadows Elementary School Parking Lot, (3yr-up)
No Fee , Time to be determined.**

BIKE TRAIL

Meadows Place has a new bike trail / walking path. The new trail has been placed along the easement between Dorrance and Monticeto. It is a ¼ mile winding path. This new trail will help support safe routes to school, provide another opportunity for health and wellness and improve the overall aesthetics of the area. This is a shared use path for pedestrians and bicyclist.
No motorized vehicles of any sort are allowed.



BRIDGE CLUB

Do you play bridge? The Bridge Club meets the 1st Tuesday of each month. If you are interested in socializing and playing cards then this is the group for you. Come and join the fun.

2/2, 9am-2pm @ Community Center -No Fee



Come out for some fun with a friendly game of kickball. We will provide the lights and the ball . You do the rest.

2/27, 7:00pm @ Majors Field (All Ages) No Fee



An accomplished award winning student teacher will be offering group tennis lessons for youth 14yr & under. This is an introductory class teaching form and the basics of the game. The classes will be taught in groups of 4 students. Each child will need a tennis racquet to participate. If you do not have one accomidations can be made. Instructor Vishal Nagrani is a sponsored athlete by Gamma Sport.(Tennis Court /TC) **Must pre register**

Single Lesson

2/8, 4:45–5:45pm @ TC (14yr & under) \$15

2/8, 6-7pm @ TC (14yr & under) \$15

2/15, 4:45–5:45pm @ TC (14yr & under) \$15

2/15, 6-7pm @ TC (14yr & under) \$15

2/22, 4:45–5:45pm @ TC (14yr & under) \$15

2/22, 6-7pm @ TC (14yr & under) \$15

Package Lesson Mondays Only

2/8-2/22, 4:45–5:45pm @ TC (14yr & under) \$40

2/8-2/22, 6-7pm @ TC (14yr & under) \$40



Sharpen your mind and strengthen your body with Hall of Famer, Master Jenny Pless. She teaches all levels of skill from basic to advanced. New full session to begin in April.

Must pre register

1/11 – 3/30, Mon. and / or Wed. @ Community Center

5-6pm (4-11yr)

6-7pm (12yr - Adult)

9 Classes \$49 / 1 class per week

18 Classes \$89 / 2 classes per week includes uniform



American Society of Karate teaches American Karate to ages 5 – 70yr in a positive ever-changing system. Its goal is to not be the largest, but to be the best. Instructor: 4th Degree Black Belt, Steve Puma and 3rd Degree Black Belt, Michael Puma. New full session to begin in April. **Must pre-register.**

1/14 – 3/31, 6:30-7:30pm every Thursday @ Community Center (5-12yr) \$45

1/14-3/31, 7:30-8:30pm every Thursday @Community Center (13yr &up) \$45

Uniform Fee paid to instructor \$30



It's a recipe for a whole lot of healthy fun. Take a heaping dose of tennis, throw in a dash of ping-pong and add a pinch of badminton and you have the formula for one of the fastest-growing sports in the country. Come out and experience the new sport of Pickleball. We will teach you the rules, fundamentals of play, and provide all the equipment. This is a low impact sport that is popular with all ages.

Active Adult

2/15, 9am @ Tennis Court , No Fee

Youth

2/15, 10am @ Tennis Court, No Fee



**YOGA - KICKBOXING
RYTHMN & DANCE**

Come for a fitness **Sneak Peek** taught by Pamela Sampson, AFAA Certified Group Fitness Instructor. This is your chance to sample three different styles or just try one.

2/10, 8:30 - 9:30 am @Community Center, (No Fee)

3/7, 7:30 – 8:30 pm @ Community Center, (No Fee)



Would you like to be a part of a national organization while making a difference in your own community? If so, now is the time to join the Meadows Place Youth Action Council. Serve as the voice of teens in the community, promote leadership through volunteerism, and make a positive impact while having fun with other teens. YAC is a great way to earn service hours and also include on your college application. This is a youth run organization. Teens create the bylaws, set the schedule, and make the plans for service, volunteering, and fun. Applications will be accepted throughout the year and can be found on the City website. Current members will attend the Texas Summit in Pearland.

Next Meeting 2/5, 6:30 – 8:30pm @ Community Center (9th-12th grade) No Fee



Support YAC Soles 4 Souls Service Project

YAC Youth will be collecting gently used or new shoes as a part of their national service project. Help us “Wear Out Poverty” by simply repurposing your gently worn shoes. 1.2 billion People live on less than \$1.25 per day. 400 million are children. Many don't have access to one of life's basic necessities: a good pair of shoes.

1/23-2/13, Donation boxes will be located at City Hall. YAC Youth will also be placing door hangers for a front door pick up

Give Shoes, Give Love





MARCH 12

CAMPOUT IN THE PARK

Come and experience the great outdoors first hand. For those who have never camped and even those who are experienced this event will be fun for all. Texas Parks and Wildlife will be joining Meadows Place Parks and Recreation to host a Family Campout at the Meadow Place Lake. We will teach the basics of campsite set up, safety, cooking, and activities. We will provide the meals and you will provide a tent and sleeping bag. Check in is at 2pm and activities will begin at 3pm. The event ends Sunday morning by 10am. This is a family event at least one parent or guardian must be registered for youth under 18 to participate.



Learn The Basics:
Setting Up Camp
Kayaking
Archery
Fishing
Wilderness 1st Aid
Dutch Oven Cooking
Starting A Campfire

Dinner
Breakfast and
S'mores
Provided

\$25 Per Family of 4
\$10 Per Individual

Must Register By
March 1

REGISTRATION **REQUIRED**

City Hall - 1 Troyan Dr
Meadows Place, 77477
281-983-2934

parksdirector@cityofmeadowsplace.org

March 12 @ 2pm thru
March 13 @ 10am

Free Estimates
Visa, MC, Discover, AMEX

Commercial-Residential
Insured

ODD JOB FENCE COMPANY

Fences Erected, Repaired & Rebuilt

Tim Tate
tate006@gmail.com
281-498-7256

Small, Big, Odd

P.O. Box 1985
Stafford, TX 77477



"Proudly Servicing Homes in Your Area for 28 Years!"

CASUAL AIR, INC.

"Fair Prices, Quality Work"

• Please have your furnace checked for proper operation by a licensed H.V.A.C. professional before turning them on! ** A very small price to pay for you and your loved ones safety.

PREVENTIVE MAINTENANCE TIP ~ FYI:

Have the duct work checked in your homes attic space for air leaks. If your home is 25-30 years old the typical "flex duct" originally installed by builders can deteriorate & literally "fall apart" due to constant heat & humidity of attic conditions in our area. This can hit you hard in the "pocketbook" (i.e. very comfortable attic space!). Not to mention your system has to work harder to comfortably heat & cool your home. Having your duct work checked can be easily scheduled during your annual fall furnace inspection. **Call Now** before you make the switch to heat.

281.498.3900
Stafford, TX 77477

FRED COMP, Owner

State Lic. & Insured
#TACLB 010694E

Kathy Swinney

Professional
Organizer

Meadows Place Resident
for 20 years



281-704-1120

*My dream is to help you Reclaim your space,
home or office, and be able to Relax in the
space you once loved or would love to love!*

Find me on Facebook at
"Reclaim and Relax Organizing"

Free consultation?

Call or text me at 281-704-1120
Just \$25/hr for Organizing Services

February Special: It's Garage Sale Month

Haul out and Set Up Services Only \$10/hour

Let me help you clear your clutter and make
some money this month.

Meadows Place Residents

WE DESERVE A NICE PARK!

Please Stop or Report
Vandalism or Misuse of Facilities

Police: 281-983-2900



DON'T MESS
WITH TEXAS

AND...
DON'T MESS WITH
Meadows Place

Stafford Fire Department



is looking for
a few new volunteers from
Meadows Place

Contact info:

Larry Di Camillo

- Fire Chief, City of Stafford Fire Department

ph: 281.208.6950
www.staffordfirerescue.org

10210 Mula Road,
Stafford, Texas 77477



NOW WITH MORE SPOTS THAN EVER!

- 🐾 Woodlands
- 🐾 Memorial
- 🐾 Tomball
- 🐾 League City
- 🐾 Katy
- 🐾 Baytown
- 🐾 Cypress
- 🐾 Kingwood
- 🐾 Downtown
- 🐾 Main Dealership in Stafford



SELL US YOUR CAR!™

 TEXASDIRECTAUTO.COM

ALL STUDENT SHUTTLE

CALL US TODAY (281) 619-8309

Why Should You Use a Shuttle Service?

- *To maintain balance with work and family schedules,
- *Your child is too old for daycare,
- *You live within the "2 mile radius" of your school,
- *You're habitually late to work or late picking up after school,
- *Your child attends a private or magnet school program,
- *Your carpool is not reliable . . .

"We'll Get 'em there when you can't!"

**CHECK
THIS OUT!**

Our Transit Operators enjoy great pay, annual bonus and holidays off! **Join our team today!**
allstudentshuttle.com/employment



Happy Valentines Day!

ORGANIZED BY
Sue
From Chaos To Order

Show some LOVE to your HOME or OFFICE



Call me for a Sweetheart of a Deal

Professional Organizing for Home & Office
281-905-0035

Still offering our 20-16 special!



RAY'S
A/C & Heating Svcs.

Tel: 281-799-2556

Maintenance * Service * Installations

- Honest & Fair Prices
- Free Estimates on New Equipment
- No Overtime Charges
- Se Habla Español

Ray Mendez
Owner / Technician
TACL26076E
Licensed & Insured

Manufacturer's Suggested Annual Maintenance

Heat check-Up
\$59.00
Reg 69.00

\$150 OFF
Any Replacement Equipment
Excludes parts
Not valid with any other discount or promotion. Offers may not be combined. One coupon per customer.

\$50.00 OFF
Any repair over \$450

Manufacturer's Suggested Annual Maintenance

A/C Check-Up
\$59.00
Reg 69.00

www.Raysmac.com You're welcome to check references
Financing available @ www.sugarlandnetwork.com

Southern Maid Cleaning

Call Leslye @ 832.655.5842

or visit
Cleanedbysouthernmaids.com

Weekly & Biweekly
Standard Cleaning
Deep Cleaning
Move In/Out

Let's make your home spotless and Sparkle!

\$10.00 off first Cleaning when you mention our ad



LET ME SAVE YOU TIME & MONEY!

Accurate, efficient and personable accounting services for a reasonable fee.

Tax Preparation & Planning
Accounting & Bookkeeping

I specialize in small to mid-size businesses including Partnerships, S-corps and C-corps as well as individuals, trusts and gift tax.



TAMARA L. MIHAIL
CPA, LLC
TAX & ACCOUNTING SERVICES

CALL OR EMAIL NOW!
(281) 989-5361
Tammy@MihailCPA.com

12135 Monticeto Lane
Meadows Place, TX 77477
www.MihailCPA.com

Meadows Place Resident

James O. McDonald

Certified Public Accountant
Serving Our Clients since 1973



Jim McDonald CPA

Income Tax Planning & Preparation

- Estimating & Planning
- Individual
- Businesses
- Sales Tax
- Property Tax
- Texas Franchise Tax
- Estate Tax

Accounting & Bookkeeping for Small & Medium Size Businesses

- Business and Personal Financial Statements.
- Monthly Bookkeeping.
- Assist in Selection of Accounting Software.
- Financial Analysis and Planning

"We are committed to providing high quality accounting service at reasonable cost. Allow us to provide your accounting services!"

Jim McDonald

7100 Regency Square Blvd • Suite 220
Houston, TX 77036 • Phone: (713) 771-4628 • Fax: (713) 532-9316

Simpson's Tree Service



- Tree Trimming
- Tree Removal
- Senior Citizen Discount!
- FREE Estimates!

\$50 OFF
All services over \$500
\$25 OFF
All services under \$500
with coupon only

Proudly Serving the Greater Houston Area for over 20 Years!

Insured for your protection..
www.SimpsonsTreeService.com

When Quality Counts...
Call 281.980.0095

'2.99 Rifa Specials All day Tues, Thurs

Call Me!
12203 Murphr Rd.
Stafford, TX 77477
281-568-9126

Sun-Thurs: 11a.m.-9p.m. • Fri-Sat: 11a.m. 10p.m.
Catering for any occasion! Family owned & operated.

FREE Entree
Buy one entree & two beverages, get one entree FREE

FREE Entree
Buy one entree & two beverages, get one entree FREE

KIDS EAT FOR 99¢
Mon - Wed, with purchase of adult entree

To advertise in your local Money Mailer call 281-236-8996
345-00-5477-1427, 128024 (LS)



Houston

Replacement Windows

Premium White Vinyl * Double Pane * Lifetime Warranty * Professional Installation * Home of the Ultimate Energy Saver * Starting at \$189!!!



Summer Specials

\$\$ Huge Savings \$\$
Call Now and Ask About
FREE Window Upgrades

**FREE
ESTIMATES**

(281) 458-4081

www.WindowCityHouston.com



LEAVINGS CONCRETE CO.

- Patios
- Driveways
- Foundations
- Sidewalks
- Lifetime Warranty on Lattice Patio Covers
- Flagstone
- Concrete Pavers
- Stamped Concrete
- Breakout & Removal

713-851-4337

drleavings@peoplepc.com



THE GALAXIE JEWELERS

WE CREATE THE UNUSUAL

Family Owned Since 1972

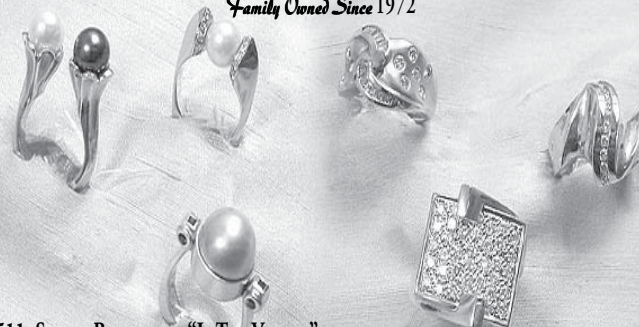

2511 SUNSET BOULEVARD "IN THE VILLAGE"
(713) 521-2511 • FAX (713) 521-3700
www.TheGalaxieJewelers.com

CLC

A Full Service Lawn Maintenance Company

281-919-3939

- *Basic Lawn Service
- *Spring Clean-ups
- *Fall Clean-ups
- *Shrub Care
- *Mulching
- *Sodding
- *Bedding Plants
- *Lawn Treatments
- *Fertilization

We will never use big heavy lawn equipment on your lawn..

Sign up for an annual agreement and receive your first years lawn fertilizer applications (up to 4) at no charge (up to \$225.00 value free).

Give us a try, you really have nothing to lose.

Ask for Raben

Bugs bugging you?
Buzz us!



FREE
Home
Evaluations
& Estimates
Not valid for WDI reports

\$100 OFF
Any Complete
Termite Treatment
With coupon.

\$25 OFF
Ant & Flea
Service
With coupon.

\$59⁰⁰
Initial
Roach Service
With coupon.

\$89⁰⁰
House &
Yard Spray
With coupon.

MEADOWS PLACE RESIDENT
Locally Owned and Operated...

- ✓ 25 Years of Experience
- ✓ Termites & General Pests
- ✓ Free Inspections
- ✓ WDI Inspections/Reports
- ✓ Insured

Direct: 281-610-1053
or 281-564-1163
MrMikePC@sbcglobal.net



Offer Ends Soon - Call Today

**AMANDA
SIMPSON**
832.520.9409

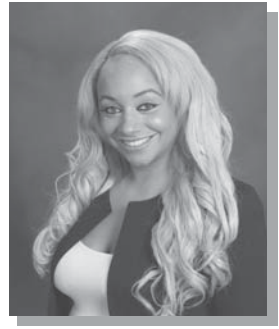

Hardworking!
Competitive!
Action Oriented! amandasimpson@kw.com

Let me help you get the
BEST deal...
👉 Extensive Market Analysis
👉 Lifelong Fort Bend Resident
👉 Honesty 👉 Integrity
👉 Service
Whether Buying or Selling..
I will work for YOU!

SOUTHWEST
KELLER WILLIAMS REALTY

Keller Williams Realty Southwest
Each office independently owned and operated.

10% off
bloodwork

Clean
polish
fluoride



FEBRUARY IS DENTAL MONTH!

WE AT CRITTER CARE ANIMAL HOSPITAL STRONGLY RECOMMEND ANIMALS, OLDER THAN TWO YEARS OF AGE AND SHOWING SIGNS OF DENTAL DISEASE HAVE THEIR TEETH CLEANED BY OUR PROFESSIONALLY TRAINED STAFF. PETS LIVE AN AVERAGE OF 3-5 YEARS LONGER WITH GOOD DENTAL HYGIENE

CRITTER CARE ANIMAL HOSPITAL
281-494-7700
WWW.CRITTERCAREONLINE.COM



free
oral exams

30% off
Dentals

DanceSport Club

11758 Southwest Freeway

(281) WE-DANCE



Ballroom/ Latin



Kids Dance



Wedding



Socials



Yoga

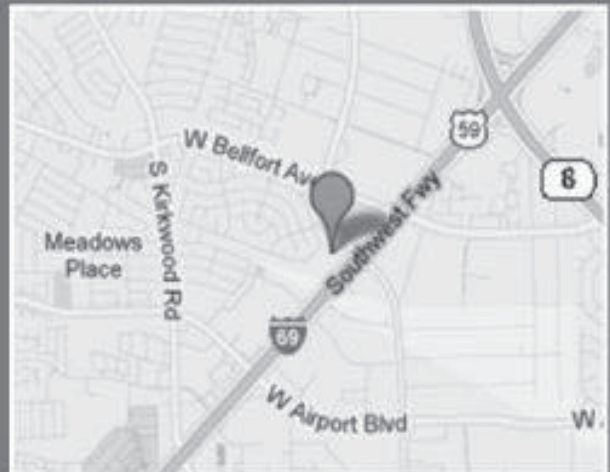

www.DanceSportClub.com

Houston Restoration Services ROOFING

Call Us Today: (281) 850-4393

www.HRSroofing.com

Due to recent storms your roof may be compromised.
Call HRS today for a FREE inspection!



- Our roof installers have been with HRS for at least 12 years
 - We are fully insured
- We are licensed to roof in Meadows Place
 - We provide same day service



"Our Quality of Work is Never Compromised"

Anita Milne

**BEARD REALTY GROUP PRESENTS MEADOWS PLACE
HOMES ON THE MARKET FOR FEBRUARY**



11811 Scottsdale



11819 Meadowtrail



11530 Kirkwood



Anita Milne

(281) 413-9732

milneanita@yahoo.com



I take the stress out of buying or selling your home!



One Troyan Drive • Meadows Place, TX 77477
www.cityofmeadowsplace.org

Prsrt Std
U.S. Postage
PAID
Stafford, TX
Permit No. 36

City of Meadows Place

One Troyan Drive • Meadows Place, TX 77477
(281) 983-2950 • Fax (281) 983-2940

- Charles D. Jessup, IV...MAYOR** (281) 642-7702
e-mail: mayor@cityofmeadowsplace.org
- Terry J. Henley...MAYOR PRO TEMPORE**..... (281) 530-7136
e-mail: alderman4@cityofmeadowsplace.org
- John F. Isbell...ALDERMAN 1** (804) 240-4982
e-mail: alderman1@cityofmeadowsplace.org
- Kelle K. Mills...ALDERMAN 5** (281) 933-0374
e-mail: alderman5@cityofmeadowsplace.org
- Steven H. Bezner...ALDERMAN 2** (281) 401-9339
e-mail: alderman2@cityofmeadowsplace.org
- Rick J. Staigle...ALDERMAN 3** (713) 446-4566
e-mail: alderman3@cityofmeadowsplace.org

Courtney Rutherford...CITY SECRETARY..... (281) 983-2931
e-mail: crutherford@cityofmeadowsplace.org

- EMERGENCY 9-1-1
- CITY HALL (9:00 a.m. - 4:00 p.m.) Mon-Fri..... (281) 983-2950
- POLICE DEPARTMENT / 24 Hours..... (281) 983-2900
- FT. BEND COUNTY SHERIFF..... (281) 342-6116
- WATER AND SEWER (832) 756-2143
- FT. BEND COUNTY COURTHOUSE (281) 342-3411
- ANIMAL CONTROL..... (281) 342-1512
- PARKS AND RECREATION DEPARTMENT (281) 983-2935

Community Center Rental

Building Capacity 165

Rental includes tables and chairs to accommodate events

Food/no alcohol.....\$200.00 Food/with alcohol.....\$300.00
(Cash deposit required equal to Rental Fee)

Community Pool Rental.....\$350.00
(after Community Hours, maximum rental time is 3 hours)

Non-Meadows Place residents add \$175.00 to above rates

Resident Community Center/ Pool Combo Rental
Available May - August

Meadows Place residents receive a \$50 discount when renting the Community Center & Pool for the same event.

For rental reservation information, go to cityofmeadowsplace.org click on Parks & Recreation, then Community Center

To check availability, call (281) 983-2935 or email: parks3@cityofmeadowsplace.org

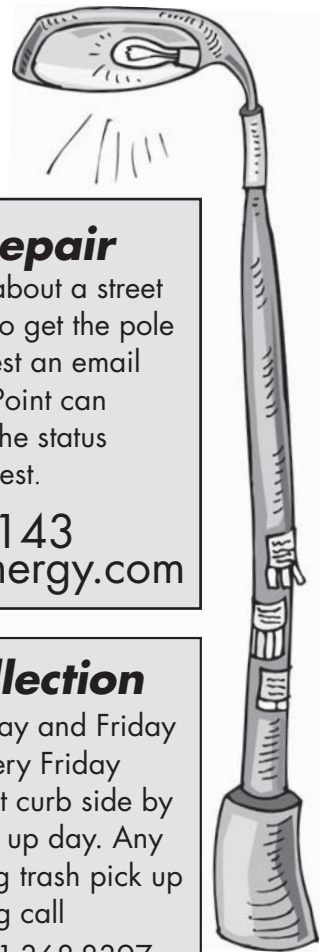

Street Light Repair

When calling or emailing about a street light outage, you will need to get the pole number. You may request an email notification so Center Point can keep you apprised of the status of the repair request.

1-800-332-7143
www.centerpointenergy.com

WCA Trash Collection

Trash pick up is every Tuesday and Friday / Recycling every Friday

Please have trash at curb side by 7:00am each pick up day. Any questions concerning trash pick up or recycling call WCA direct at 281-368-8397.

Storm Water Hotline

Report dumping in storm water drains. Only **RAIN WATER** is allowed

281-983-2932 or report online, see website. For updates on Public Works News visit the website.

publicworks@cityofmeadowsplace.org